

HYDRO-STOP® PVC WATERSTOP

INTERNATIONAL PROFILES

HIGH PERFORMANCE SPECIFICATION (HPS) GRADE



PRODUCT DESCRIPTION

CJSA Hydro-Stop® PVC Waterstops lead the way in high technology waterstops and comply with international standards.

Hydro-Stop® PVC Waterstops are extruded from specially compounded PVC in accordance with BS2571 and they are designed for use in water retaining and water excluding structures where a positive seal is required for poured in-situ concrete expansion, construction and contraction joints.

Hydro-Stop® PVC Waterstops are designed for use in many types of applications and structures, and are available in a number of different size profiles to suit a project's requirement.

Hydro-Stop® PVC Waterstops are available in rolls with separate intersections supplied to simplify and minimise on-site fabrication. The waterstop is heat weldable and allows for fast and easy on-site welding/joining.

The efficiency of any waterstop is very dependent on good workmanship, installation, and on full compaction of the surrounding concrete around the waterstop during concrete placement. Optimum performance will be achieved if the waterstop is installed by keeping these important factors in mind.

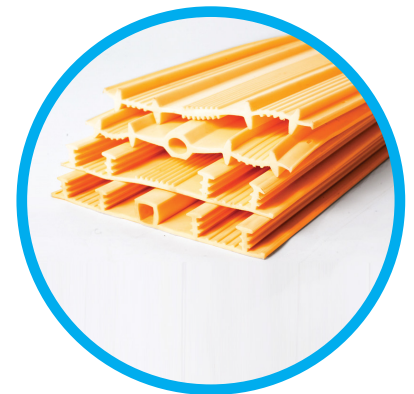

ADVANTAGES

- A full range of profiles and sizes to suit all types of construction requirements
- **Hydro-Stop® PVC Waterstops** conform to, and exceed all major international standards
- High quality compounded PVC for long term durability and integrity
- Factory made intersections to simplify and minimise on-site fabrication
- On-site welding equipment is available upon request
- Internal profiles come with factory pre-punched eyelets for easy and secure wire tying to reinforcement
- Ability to withstand high hydrostatic head pressures



AREAS OF APPLICATION

Water retaining structures:

- Water tanks
- Water treatment plants
- Sewage treatment plants
- Swimming pools
- Dams and spillways
- Reservoirs
- Bund walls

Water excluding structures:

- Basements
- Underground car parks
- Tunnels
- Retaining walls
- Suspended slabs
- Below ground slabs
- Roof & podium slabs

Note : *The product's design and performance, its intended use, installation and final confirmation and approval for use, must be provided by the project's Design Engineer and Project Manager.*



TYPICAL APPLICATIONS

EXPANSION JOINT

CONSTRUCTION JOINT

STANDARD DETAIL OF WALL APPLICATIONS

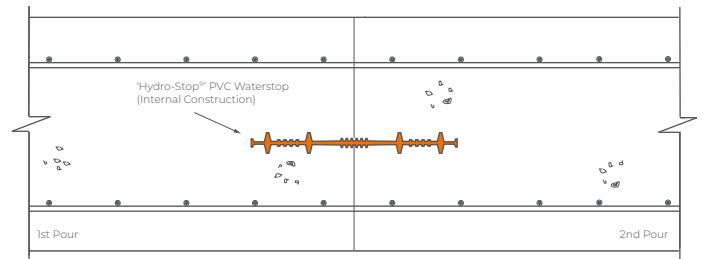
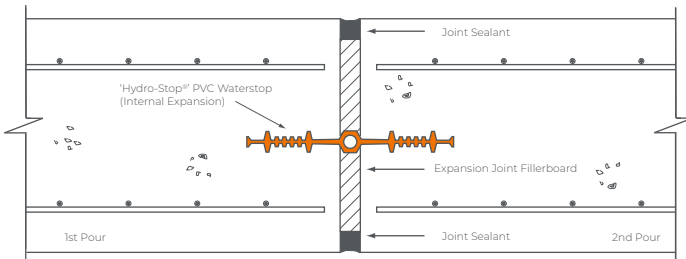

STANDARD DETAIL OF GROUND SLAB APPLICATIONS

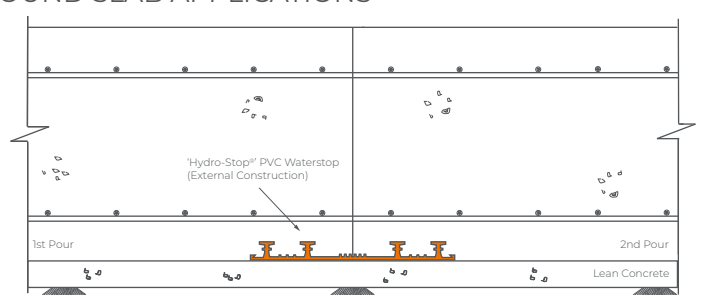
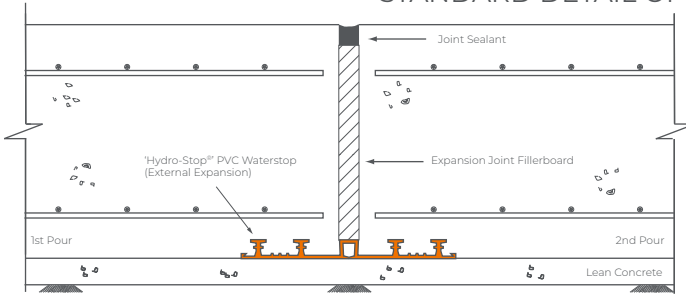

TECHNICAL FEATURES

COLOUR	Orange
PACKAGING	150mm - 20m = 20m roll, 250mm = 15m roll, 320mm = 12m roll
ROLL WEIGHT	Dependent upon profile type
STORAGE CONDITIONS & SHELF LIFE	5 years from the date of production if stored properly in original, unopened and undamaged sealed packaging, in dry conditions out of direct sunlight at temperatures between +10°C and +40°C
MATERIAL TYPE	Polyvinyl Chloride (PVC)
WELDING TEMPERATURES	Approximately 190°C - 200°C
SERVICE TEMPERATURE RANGE	-25°C to +70°C



PHYSICAL PROPERTIES

PROPERTY	TEST METHOD	REQUIREMENT	RESULT
Tensile Strength (N/mm ²)	BS 2782:320A	Min. 15.00	19.12
Elongation At Break (%)	BS 2782:320A	Min. 350	360
Loss of Mass Test (mg/cm ²)	BS EN 60811-3-2:1995	N/A	1.85
Water Absorption at 23°C (%)	ISO 62	N/A	0.15
Specific Gravity (g/cm ³)	BS 2782:620B	1.27 ± 0.03	1.29
Thermal Stability Congo Red Test at 180°C, Min.	BS 2782:130A	N/A	50
Hardness, Shore A	BS 2782:365B	75 ± 5	71

Note : Refer to CJSAs in house Certificate of Analysis (COA) dated 13/09/2017 for test results pertaining to the above. Internal COA's are conducted on every batch of raw material that is used in the production of Hydro-Stop® PVC waterstops. Independent laboratory test results are also available upon request. Project specific material properties can be custom compounded to suit. Material properties can vary between batches.



INTERNAL PROFILES

FOR EXPANSION JOINTS

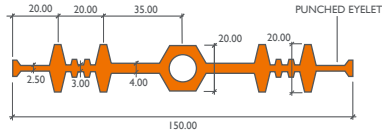

CJ 951

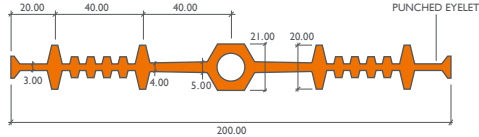

CJ 952

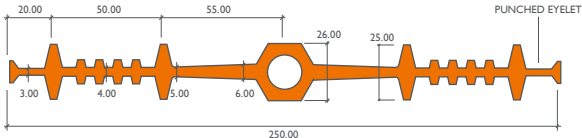

CJ 953

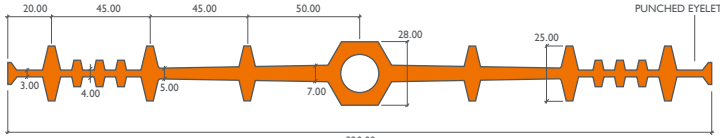

CJ 954

FOR CONSTRUCTION JOINTS

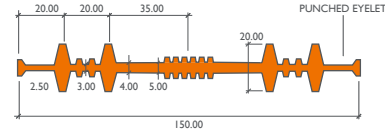

CJ 955

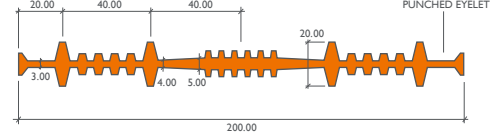

CJ 956

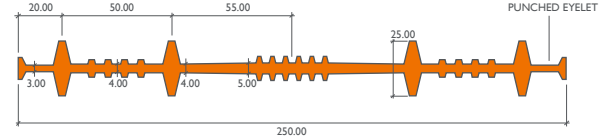

CJ 957

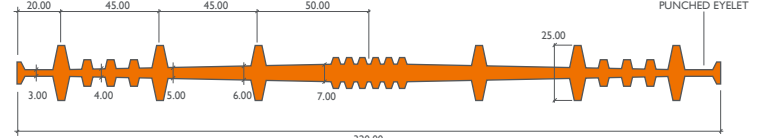

CJ 958

EXTERNAL PROFILES

FOR EXPANSION JOINTS

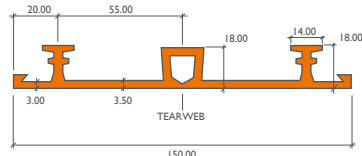

CJ 923

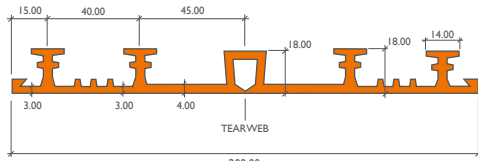

CJ 924

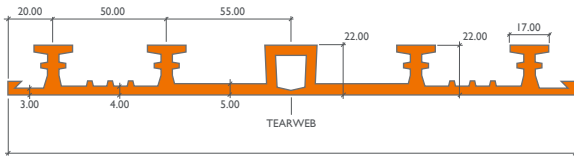

CJ 925

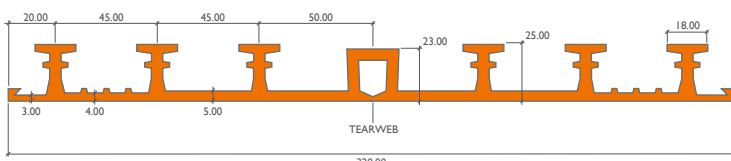

CJ 926

FOR CONSTRUCTION JOINTS

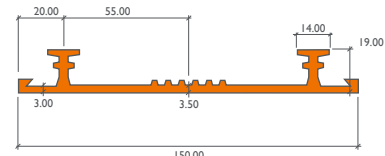

CJ 927

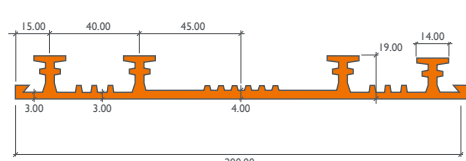

CJ 928

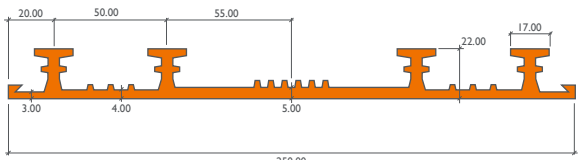

CJ 929

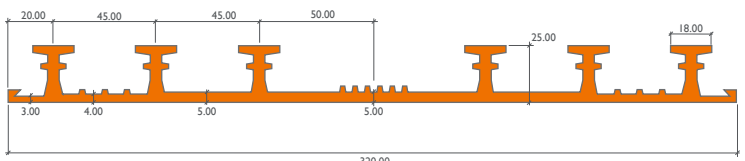

CJ 930

NOTE: Full dimension drawings available upon request

PROFILE WIDTH SELECTION

The width of waterstop depends upon the thickness of the concrete and positioning of the reinforcement. The thickness of the concrete should be greater than or equal to the width of the waterstop profile. Refer to your engineer for further clarification and approval.

SITE JOINING

CJSA recommends the use of its specialised welding equipment for on-site welding which consists of thermostatically-controlled Welding Irons and special Welding Jigs (each type of **CJSA Hydro-Stop® PVC Waterstop** requires its own welding jig to suit the particular shape). On-site joining is a simple exercise using **CJSA** Heat Welding Equipment comprising of an adjustable Welding Jig and Welding Iron. The ends of the waterstop are cut square and placed into the adjustable Welding Jig, then push the ends of the waterstop against the Welding Iron and bring the two ends together until the molten ends of the PVC fuse. When ordering Welding Equipment, please advise profile number of the waterstop required.

FACTORY MADE INTERSECTIONS

A wide range of standardised prefabricated intersection pieces are available allowing easy site welding of butt joints to **Hydro-Stop® PVC Waterstop** junction pieces. Customised pieces can be made to suit. In such cases, drawings must be provided giving exact dimensions and jointing details.

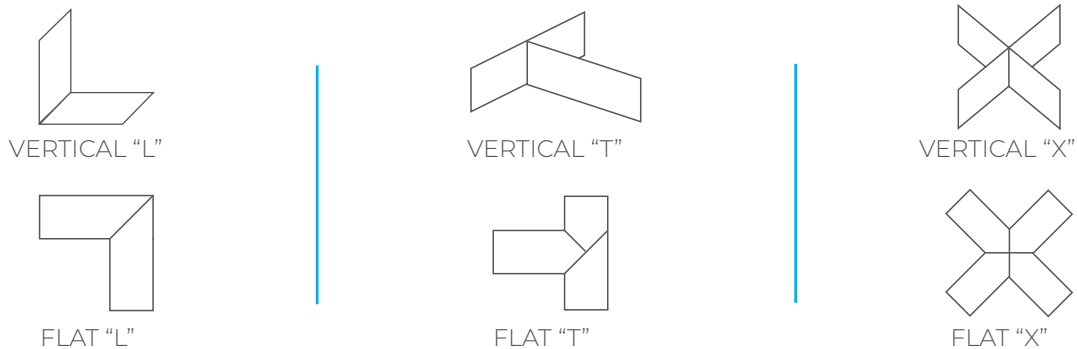

WRITTEN SPECIFICATION

Where shown on the drawings waterstops shall be **Hydro-Stop® PVC Waterstop** (state profile number required) as supplied by **CJSA**. Provide factory made waterstop fabrications for all changes of direction, intersections and transitions, leaving only straight butt joined splices for on-site fabrication.

HEALTH AND SAFETY INFORMATION

Joining of PVC Waterstops is performed by heat welding which results in the discharge of hydrogen chloride mist and vapour. In confined spaces or in still air conditions, the use of a ventilation fan or suitable respirator should be used, and the advice and approval of the Site Safety Supervisor is essential. For further information or advice on health and safety precautions, safe handling, storage and correct disposal of products, please refer to the most recent product Safety Data Sheet (SDS), which is available upon request.



DISCLAIMER

The information and the recommendations relating to the application and end use of this product are given in good faith and are based on the information provided by the manufacturer of the product and/or the Company's current knowledge and experience in connection with the product when properly stored, handled and applied under normal conditions and no liability of final function at the job site is assumed. In practice, the differences in materials, substrates and actual site conditions are such that no warranty in respect of merchantability of, or fitness for, particular purpose, nor any liability arising out of any legal relationship whatsoever, can be inferred either from this information, or from any written and/or oral recommendations, or from any other advice offered by the Company. The Company also has no express or implied knowledge of any particular purpose for which the product is required and any such information given will not be taken into account in the supply of this product. No responsibility or liability by the Company will be accepted for misuse, misreading or derivation from recommended guidelines in respect of this product and the user shall determine the suitability of the product for his intended use and assume all risks and liability in connection therewith. The information contained in our brochure may change at any time without notice. Any use of this product, **Hydro-Stop® PVC Waterstop**, in any application should be approved as suitable for use/application by the Design Engineer and Project Manager.

Effective Date: 09 APRIL 2021

CJSA

- Unit 2, 18 Farrow Circuit Seaford Rise, South Australia 5169, AUSTRALIA
- +61 432 423 103
- admin@cjsa.net.au